

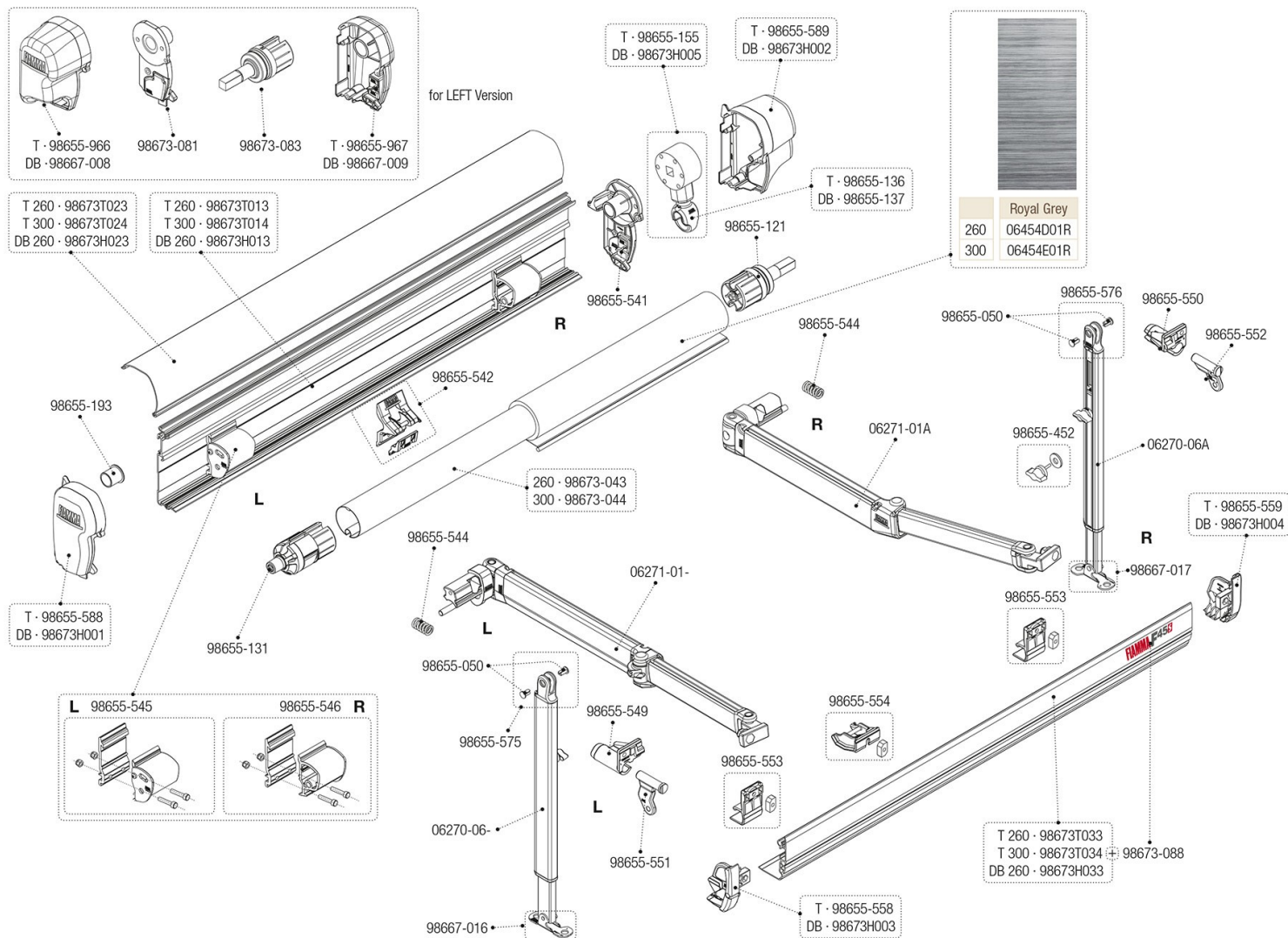









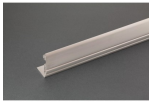
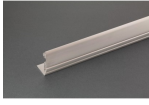
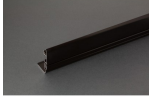

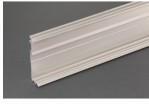
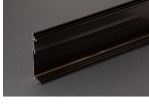











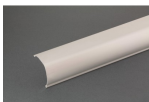
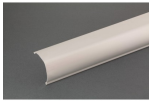
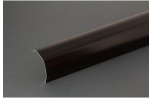





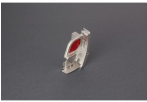

F45S VW T5 TITANIUM 260-300 - DEEP BLACK 260









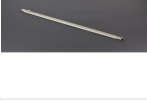
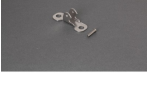

	RÉFÉRENCE	LA DESCRIPTION	PRIX *
	98655-552	ARTICULATION PIED DROIT F45 S	€ 10.90
	98655-551	ARTICULATION PIED GAUCHE F45 S	€ 10.90
	98673-083	AXE D'ENTRAIN.GAUCHE D48 F45S LEFT	€ 39.50
	98655-121	AXE D'ENTRAINEMENT DROIT D. 48	€ 39.50

	98655-193	BAGUE POUR ROULEAU DE STORE (1PC)	€ 5.50
	98673T033	BANDEAU FRONTAL ANODISE 260 F45S T.	€ 121.00
	98673T034	BANDEAU FRONTAL ANODISE 300 F45S T.	€ 138.00
	98673H033	BAUNDEAU FRONTAL D.BLACK F45S 260	€ 122.00
	98673T013	BOITIER ANODISE 260 F45 S TITANIUM	€ 181.00
	98673T198	BOITIER ANODISE 300 F45 S TITANIUM	€ 200.00
	98673T014	BOITIER ANODISE 300 F45 S TITANIUM	€ 200.00
	98673H013	BOITIER DEEP BLACK 260 F45 S	€ 181.00
	98673-197	BOITIER F45S 260 P.W VWT5/T6	€ 181.00
	98673T197	BOITIER TITANIUM 260 F45 S VWT5/T6	€ 181.00
	98655-131	BOUCHON PRESTO FIX D. 48	€ 8.40
	06271-01A	BRAS DROIT F45 S 250/260 EXT. 200	€ 188.00
	06271-01-	BRAS GAUCHE F45 S 250/260 EXT. 200	€ 188.00
	98655-589	CACHE DE PROTECT.DROITE F45S TITAN.	€ 20.40

	98655-588	CACHE DE PROTECT.GAUCHE F45S TITAN.	€ 38.60
	98667-009	CACHE PROTEC. DROIT F45S LEFT BLACK	€ 38.60
	98673H002	CACHE PROTEC.DROIT F45S DEEP BLACK	€ 38.60
	98655-967	CACHE PROTECT.DROITE F45S TIT.LEFT	€ 38.60
	98655-966	CACHE PROTECT.GAUCHE F45S TIT.LEFT	€ 38.60
	98667-008	CACHE TREUIL GAUCHE F45S LEFT BLACK	€ 38.60
	98673T023	COUVERCLE BOIT.ANODISE 260 F45S TIT	€ 90.70
	98673T024	COUVERCLE BOIT.ANODISE 300 F45S TIT	€ 104.00
	98673H023	COUVERCLE BOITIER D.BLACK 260 F45S	€ 90.70
	98655-136	CROCHET TREUIL F45I-TI/F1/F65S TIT.	€ 6.20
	98655-137	CROCHET TREUIL F65 S DEEP BLACK	€ 6.20
	98673H004	EMBOUT BAND.FRON.DROIT F45S D.BLACK	€ 11.30
	98655-559	EMBOUT BAND.FRON.DROIT F45S TIT.	€ 11.30
	98673H003	EMBOUT BAND.FRON.GAUCHE F45S BLACK	€

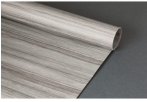
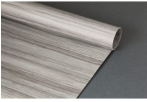
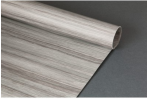
	98655-558	EMBOUT BAND.FRON.GAUCHE F45S TIT.	€ 11.30
	98655-541	EMBOUT DROIT POUR BOITIER F45 S	€ 20.60
	98673-081	EMBOUT GAUCHE P.BOITIER F45S LEFT	€ 20.60
	98673-088	ETIQUETTE FIAMMA F45 S	€ 7.70
	98655-554	KIT FIX.RAFTER AU B.FRONTAL F45 S	€ 8.50
	98655-452	PAPILLON DE SERRAGE PIED DU STORE	€ 5.20
	98655-576	PARTIE TERMINAL PIED DROIT F45S	€ 12.50
	98655-575	PARTIE TERMINAL PIED GAUCHE F45S	€ 12.50
	98655-550	PATTE DE FIXAT.PIED DROIT F45S	€ 8.50
	98655-549	PATTE DE FIXAT.PIED GAUCHE F45 S	€ 8.50
	98655-542	PATTE FIXAT. RAFTER BOITIER F45S/L	€ 10.90
	98655-546	PATTE INT.DROITE BOIT.F45S(250-400)	€ 27.40
	98655-545	PATTE INT.GAUCHE BOIT.F45S(250-400)	€ 27.40
	06270-06A	PIED DROIT F45S 250	€ 55.00
	98667-017	PIED DROIT POUR PIED DE SUPPORTF45/F65	€ 7.90

	06270-06-	PIED GAUCHE F45S 250	€ 55.00
	98667-016	PIED GAUCHE POUR PIED DE SUPPORT F45/F65	€ 7.90
	98655-553	PLAQUE DE FIX. PIED AU B.FRONT. F45S	€ 8.40
	98655-544	RESSORT POUR PATTE INTER. F45 S	€ 7.00
	98655-050	RIVET SNIP-SNAP POUR PIED STORE(2PC	€ 2.50
	98673-043	ROULEAU GALV. D.48 260 F45 S	€ 50.50
	98673-044	ROULEAU GALV. D.48 300 F45 S	€ 55.90
	06454D01R	TOILE 260 ROYAL GREY F45 S	€ 198.00
	06454E01R	TOILE 300 ROYAL GREY F45 S	€ 210.00
	06454E01R	TOILE 300 ROYAL GREY F45 S	€ 210.00
	98673H005	TREUIL+CROCHET BLACK F45 S	€ 61.10
	98655-155	TREUIL+CROCHET TITAN.F45I/F45TI/F1	€ 61.10

* Les prix mentionnés correspondent aux prix public conseillés, inclus TVA 20%, droits, montage et transport non compris.